

Verbindung
der Verkleidung
an den Ecken.

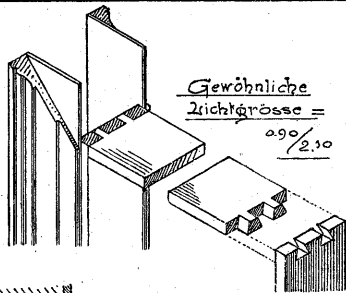

Gewöhnliche
Zichtgröße =
290/230

Verkeilung
eines
Thürechts.

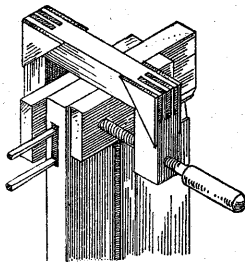

Gestemmte einflügel. Zimmerthüre
auf Hobel mit 15^{cm} tiefem glatten (40^{cm}
f. gestemmtem) Futter, beiderseitig profil. Ver-
kleidg. u. eichenem Schwellbret. (gestämter
eich. Schwelle)

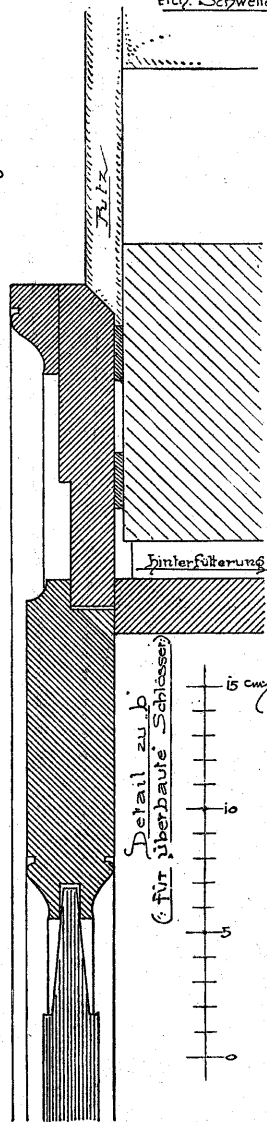
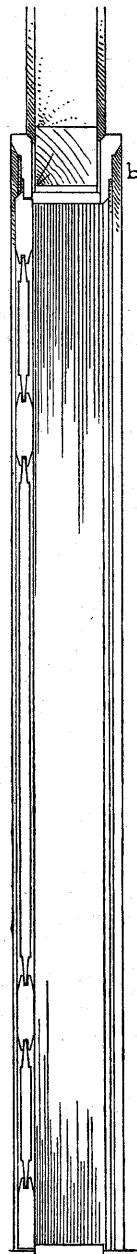
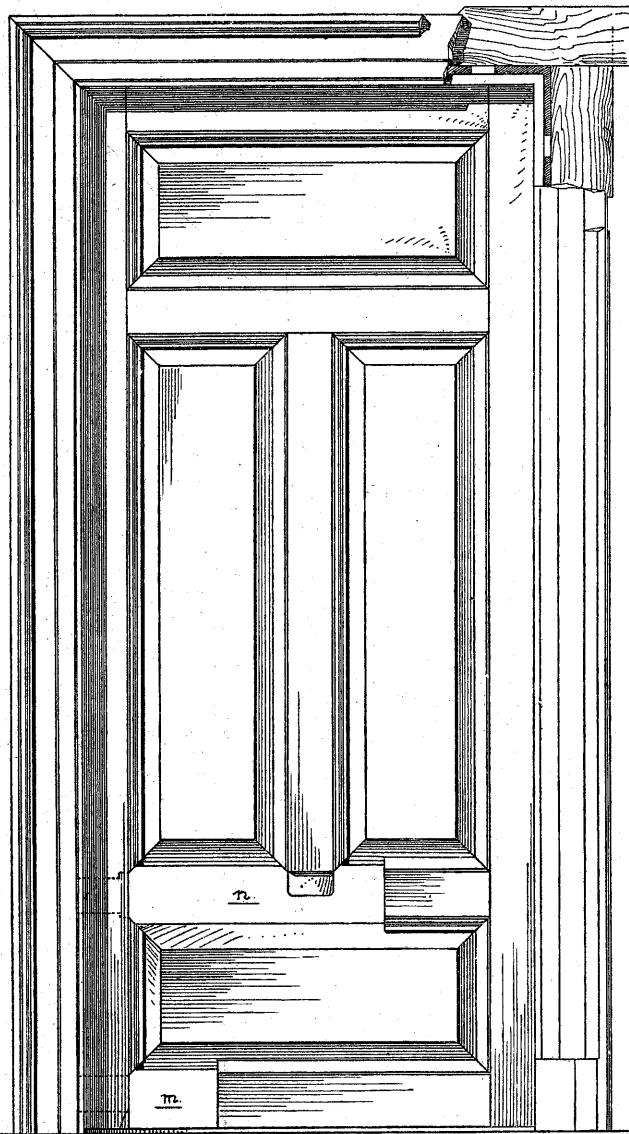
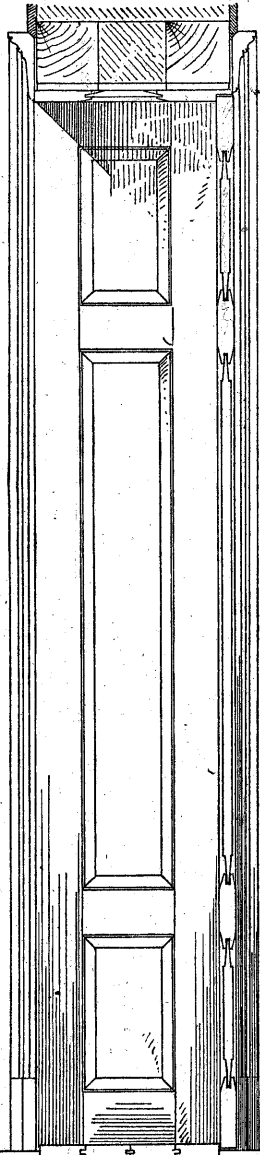

Querschnitt (Variation
bei 40^{cm} tiefem Futter.)

f und g sind die
bei m und n heraus-
gehobenen Fries-
stücke.

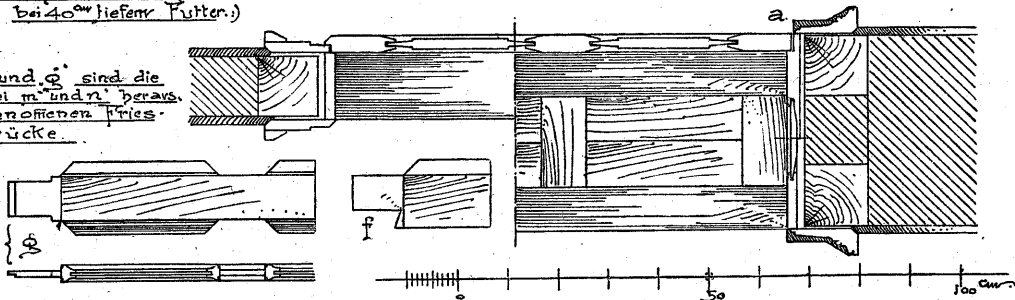

Gestemmte einflügelige Zimmerthüre.

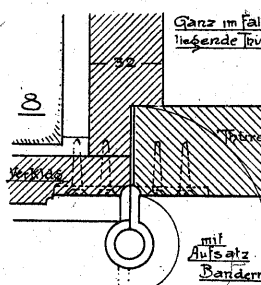
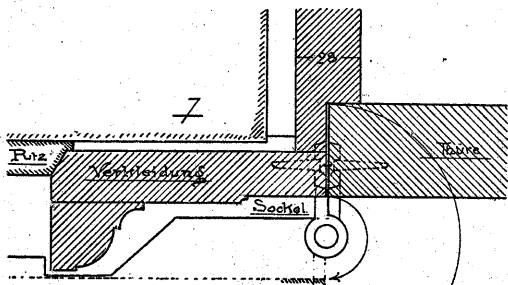
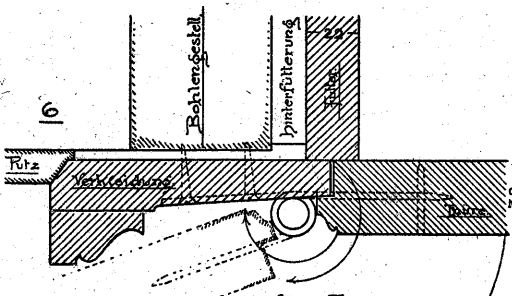
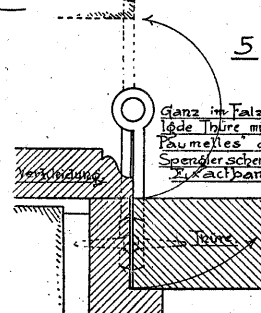
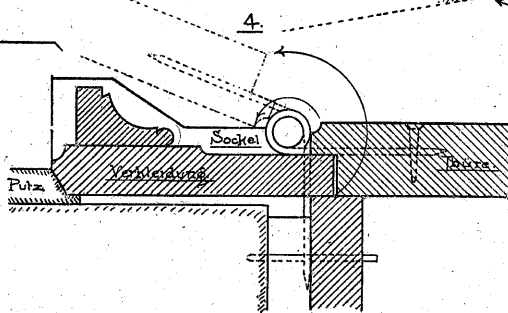
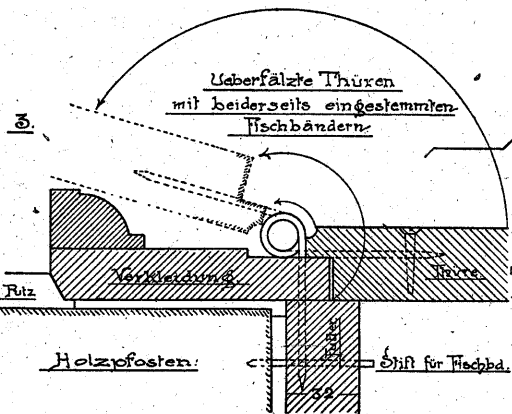
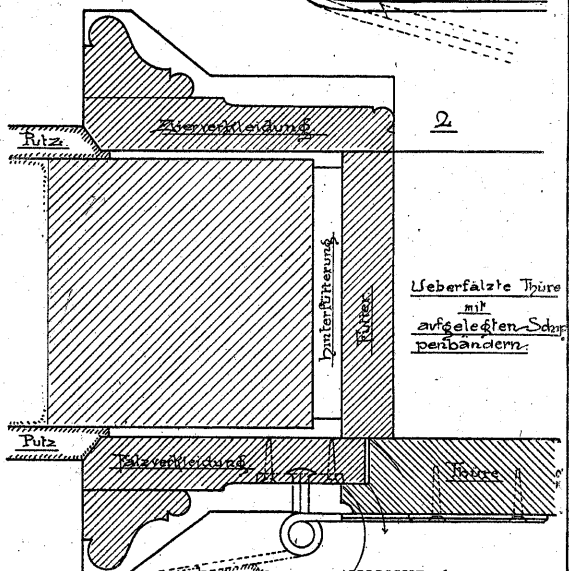
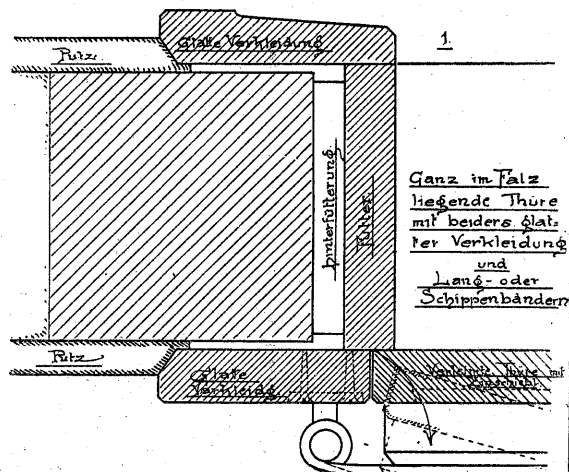
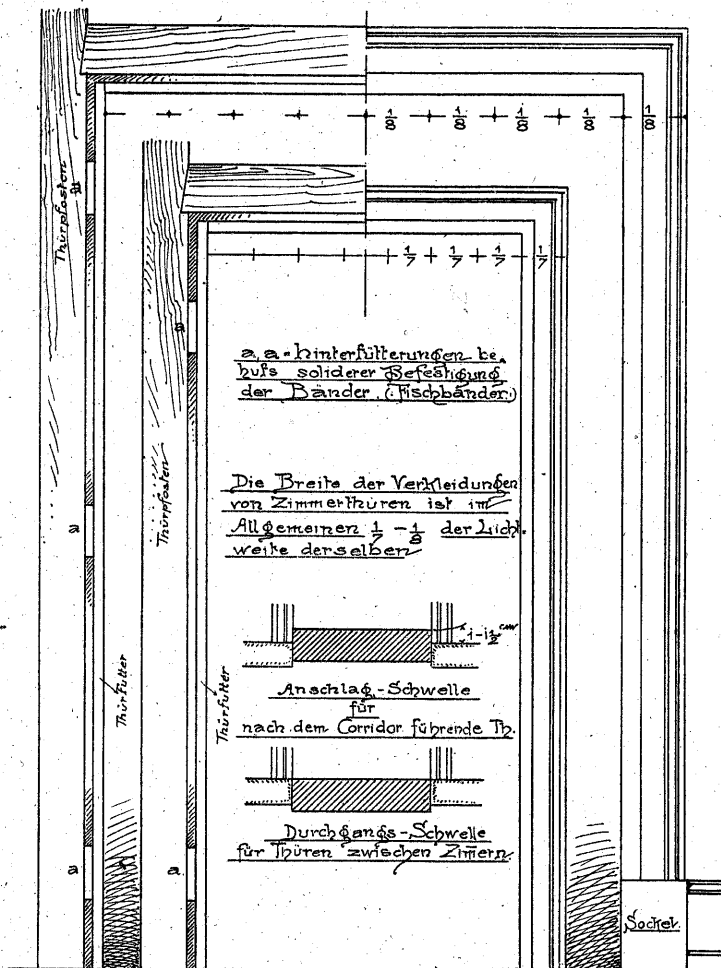

Thürverkleidungen.